

PART 7 – DEFINITIONS

Chapter 1 – Definitions

Section 7-101	General Definitions and Terms
Section 7-102	A
Section 7-103	B
Section 7-104	C
Section 7-105	D
Section 7-106	E
Section 7-107	F
Section 7-108	G
Section 7-109	H
Section 7-110	I
Section 7-111	J
Section 7-112	K
Section 7-113	L
Section 7-114	M
Section 7-115	N
Section 7-116	O
Section 7-117	P
Section 7-118	Q
Section 7-119	R
Section 7-120	S
Section 7-121	T
Section 7-122	U
Section 7-123	V
Section 7-124	W
Section 7-125	X
Section 7-126	Y
Section 7-127	Z

CHAPTER 1 – DEFINITIONS

Section 7-101 General Definitions and Terms.

For the purpose of this Code, the following words or terms shall carry full force when used interchangeably: lot, plot, parcel, premises or site; used, arranged, occupied, or maintained; sold or dispensed; construct, reconstruct, erect, alter (structurally or otherwise), but not the term maintenance. The word "used" shall be deemed also to include designed, intended or arranged to be used. Certain terms and words are also defined in Section 1-210, Interpretation.

Section 7-102 “A” Definitions.

Accessible, accessibility means accessible to persons with disabilities, consistent with the Americans with Disability Act (ADA).

Accessory building means a detached subordinate building containing an accessory use and situated on the same lot as the primary building. Detached garages, sheds, workshops, and barns are examples of accessory buildings.

Accessory dwelling, accessory dwelling unit means a small, secondary leaseable housing unit on a lot with a single-family dwelling. Accessory dwellings are limited in size and restricted to certain zone districts. They can be attached to the primary dwelling or not attached. An accessory dwelling may also be located above a garage that is either attached to the primary dwelling or free-standing.

Accessory structures means a non-habitable structure.

Accessory use means either a subordinate use of a building, other structure, or tract of land under the following situations:

1. Whose use is clearly incidental and customary to the use of the primary building, other structure or use of land; and
2. Which is located on the same zoned lot with the principal building, other structure or use of land, and whose use is specifically permitted in a less restricted district.

Access way means an area accessible for pedestrians and non-motorized vehicles, which are not a separated path, but are in the form of an alley way, pedestrian plaza, promenade, etc.

Adaptive reuse means the practice of adapting existing buildings for new purposes when the original use of a building changes or becomes obsolete.

Adult cabaret means a nightclub, bar, restaurant, or similar commercial business which regularly features:

1. Persons who appear in a "state of nudity";
2. Live performances which are characterized by the exposure of "specified anatomical areas" or by "specified sexual activities"; or
3. Films, motion pictures, video cassettes, slides, or other photographic reproductions which are characterized by the depiction or description of "specified sexual activities" or "specified anatomical areas".

Adult motel means a hotel, motel or similar commercial establishment that:

1. Offers accommodations to the public for any form of consideration; provides patrons with closed-circuit television transmissions, films, motion pictures, video cassettes, slides or other photographic reproductions that depict or describe "specified sexual activities" or "specified anatomical areas" as one of its principal business purposes;
2. Offers a sleeping room for a period of time that is less than ten (10) hours; or
3. Allows a tenant or occupant of a sleeping room to sub-rent the room for a period of time that is less than ten (10) hours.

Adult motion picture theater means a commercial business where, for any form of consideration, films, motion pictures, video cassettes, slides, or similar photographic reproductions are regularly shown which are predominantly characterized by the depiction or description of "specified sexual activities" or "specified anatomical areas".

Adult-oriented business means the opening or commencement of, or the conversion of an existing business to, or the addition to any other existing business of, or the relocation of any of the following: "adult arcade", "adult retail store", "adult motion picture theater", "adult theater", "adult cabaret", "adult motel", "escort", "escort agency or bureau", "nude model studio", "adult service", "adult service business", and "adult video facility".

Adult retail store means a commercial establishment which devotes more than one third (1/3) of its total retail sales floor area¹ to any of the following:

1. The sale or rental, for any form of consideration, books, magazines, periodicals, photographs, films, motion pictures, video cassettes or video reproductions, slides, or other printed or visual matter that predominantly depict or describe "specified sexual activities" or "specified anatomical areas"; or
2. The sale or rental of instruments, devices, or paraphernalia that are designed for use in connection with "specified sexual activities", excluding condoms and other birth control and disease prevention products; or
3. The regular exclusion of all minors from the premises because of the sexually explicit nature of the items sold, rented or displayed therein.

¹ For the purpose of determining one third (1/3) of the total retail sales floor area, display items shall be clearly separate from the remaining merchandise and shall not be visible from the remaining two thirds (2/3) of the retail sales floor area, separated by a solid non-transparent partition, and shall not be visible from the exterior of the business.

Adult service means a dance, performance or other activity, including, but not limited to, service of food or beverages, modeling, posing, wrestling, singing, reading, talking, or listening conducted for any consideration in an adult service business by a person who is nude during all or part of the time that the person is providing the service.

Adult service business means a commercial establishment where any adult service is provided to patrons in the regular course of business and as one of the principal business purposes of the establishment, and includes, but is not limited to, a nude model studio as defined in this Code.

Adult video facility, adult theater or adult arcade, referred to as *adult video facility* in this Code, means a commercial establishment where, for any consideration, the public is permitted or invited wherein films, motion pictures, video cassette projections, slides, photographs or other visual media predominantly characterized by depiction of "specified sexual activities" or "specified anatomical areas" are shown electronically, electrically, mechanically or by other means in the regular course of business and as a business purpose of the establishment. *Adult video facility* does not include a theater where all viewing occurs in a common area with seating for fifty (50) or more persons.

Advertising copy see "sign."

Alley means a dedicated right-of-way, other than a street, that provides rear property access or service needs.

Alteration means a physical change to a structure or site. Alteration does not include normal maintenance and repair or total demolition. Alteration does include the following:

1. Changes to the facade of a building;
2. Changes to the interior of a building;
3. Increases or decreases in floor area of a building;
4. Changes to other structures on the site or the development of new structures;
5. Changes to exterior improvements;
6. Changes to landscaping; and
7. Changes in the topography of the site.

Alteration, exterior means a physical change to a site that is outside of any buildings. Exterior alteration does not include normal maintenance and repair or total demolition. Exterior improvements include surface parking and loading areas, paved and graveled areas, and areas devoted to exterior display, storage, or activities. It includes improved open areas such as plazas and walkways. Exterior alteration does include the following:

1. Changes to the facade of a building;
2. Increases or decreases in floor area that result in changes to the exterior of a building;
3. Changes to other structures on the site or the development of new structures;
4. Changes to exterior improvements;
5. Changes to landscaping; and
6. Changes in the topography of the site.

Amusement game arcade means a building or portion thereof having within its premises:

1. Ten (10) or more *amusement game devices*; or
2. Fifteen percent (15%) of the net floor area of the primary use or nine (9) or fewer amusement game devices when not utilized in conjunction with a primary commercial use which is permitted by right or as a conditional use. Net floor area for the purpose of this definition is that area available for customer use.

Amusement game device means any electrical or mechanical apparatus or device for which payment is charged for use as a game or contest, including video games and pinball machines, but not including:

1. Vending machines;
2. Juke boxes;
3. *Billiards hall*; and
4. *Adult video facility*.

Antenna dish see "*mechanical equipment*".

Apartment house means any building, or portion thereof, which is designed, built, rented, leased, let or hired out to be occupied as the residence of three (3) or more families living independently of each other and where each has cooking facilities.

Attached single-family housing see "*single-family dwelling, attached*".

Auto Body repair means an automotive retail sales and service use in which one (1) or more of the following activities are carried out:

1. Reconditioning of any type of motorized vehicle, including any repairs made to vehicles over ten thousand (10,000) pounds gross vehicle weight;
2. Collision services, including body, frame or fender straightening or repair;
3. Overall painting of vehicles or painting of vehicles in a paint shop;
4. Dismantling of motorized vehicles in an enclosed structure.

Automobile wrecking yard see "junkyard".

Auto title loan means a business that operates as a short term loan company which provides a loan by holding the title of an automobile.

Section 7-103 “B” Definitions.

Bar means an establishment, including, but not limited to, a cocktail lounge, discotheque, night club or tavern, the main use of which is to serve spirituous liquors for on-site consumption. Such a facility may serve food, provide dancing and entertainment as well as operate equipment commonly found in a video or live arcade, as an accessory use (s) to the bar. See also, “pub.”

Bed and breakfast means a use providing lodging and meals for guests in not more than five (5) bed rooms on a daily or weekly basis in an operator- or owner-occupied dwelling that is primarily used for this purpose. The use is operated as a commercial enterprise, provides direct bookings from the public, and includes inns that operate restaurants offering meals to overnight guests.

Billiards hall means an establishment containing four (4) or more billiard tables and which may indulge in the sale of alcoholic beverages, as well as the operation of equipment commonly found in a video arcade.

Block means that property abutting one side of a street and lying between the two (2) nearest intersecting streets, or nearest intersecting street and railroad right-of-way, unsubdivided land, or waterways, but not an alley, of such size as to interrupt the continuity of development on both sides thereof.

Figure 7-103 A.

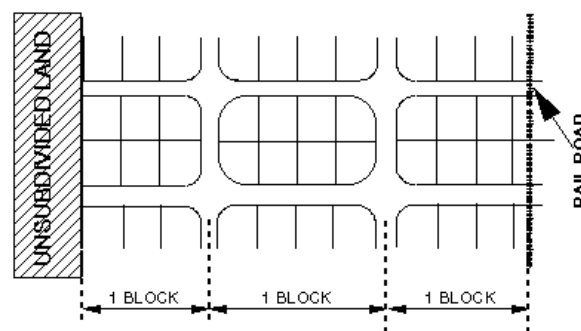

Boarding room means a room within a single-family residence, which is designed or intended to be used by paying guests of the occupants of the single-family residence.

Building means any structure, either temporary or permanent, having a roof and used or built for the shelter or enclosure of persons, animals or property of any kind. This shall include tents, awnings or vehicles situated on private property and used for purposes of a building.

Building addition means any extension or increase in floor area or height of a structure.

Building, attached means a building with an internally accessible connection through an enclosed air conditioned space, or a building with an integral roof structure which utilizes the main buildings wall to enclose the space of the attached building.

Building, enclosed means a structure completely enclosed by a roof and walls of approved construction.

Building height means the vertical distance measured from *grade* (as defined herein) to the highest point of the roof, including any parapet.

Figure 7-103 B.

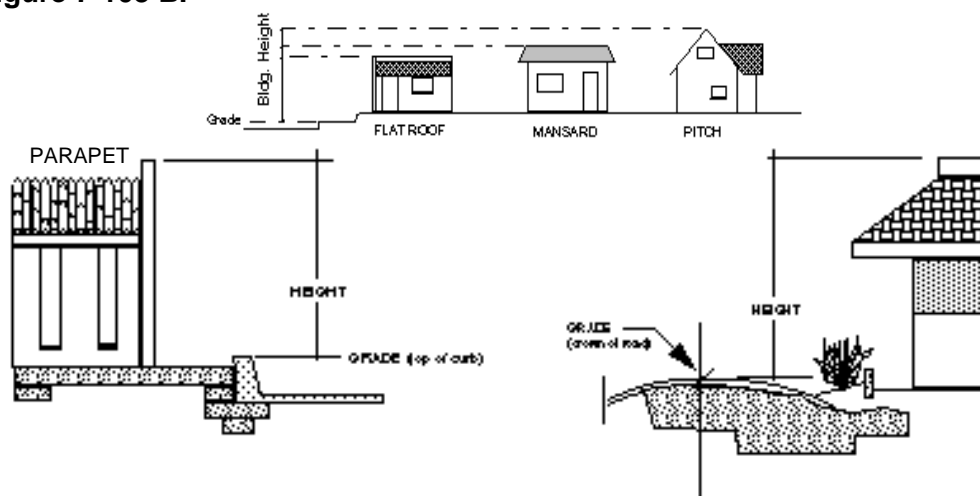

Building official means the person designated by the City of Tempe's Community Development Director, or designee, who is charged with the administration and enforcement of the building codes, as adopted and amended by the City of Tempe, or the building official's authorized representative.

Building, main (also referred to as the primary building) means a building where the principal use of the lot is conducted. In any residential district, any dwelling shall be the main building of the lot; except where an accessory dwelling exists, only one dwelling, the primary dwelling, shall be deemed the main building.

Business frontage means the main entrance frontage of the building or tenant space. For businesses with the main entrance at the building corner, business frontage shall be the longer of the two facades adjacent to the main entrance. When a business has a façade adjacent to a public street, other than the main entrance, that façade(s) shall also be considered business frontage.

Section 7-104 “C” Definitions.

Card room / poker room means a function that exclusively offers card games for play by the public. The players compete against each other, instead of against "the house", for monetary value.

Call center means any place of business where the primary activity is telephone or computer solicitation, survey or other function that is similar.

Car wash means a car washing facility; it includes both automated and non-automated facilities, self-serve and full-serve (i.e., with and without employees on-site). Windshield repair is an accessory use.

Car wash, automatic means a conveyer or automated type car washing facility that may or may not have any employees on-site.

Childcare centers means any use, regulated by the State of Arizona involving the care of other people's children during the day and that accommodate more than four (4) children for childcare. Some instruction may be offered in connection with such care. The use shall not be considered a "school" within the meaning of this Code. See also, nursery and day care school.

Childcare, in home means the use of a caregiver's residence for childcare, regulated by the State of Arizona involving the care of other people's children during the day. See also, Nursery and day care, in home.

Church means a permanently located building where persons regularly assemble for religious worship and which is maintained and controlled by a religious body to sustain public worship and church-related uses. See a "place of worship".

Civic use see "public uses".

Clinic means a building in which one or more physicians work including supplying pharmaceutical and optical needs, conducting medical tests, or other common ancillary uses to a medical office, without overnight patient occupancy; servicing humans (medical, dental) and small animals (veterinary).

Club, private means an institution used for athletic, social or recreational purposes and operated by a private nonprofit organization, membership to which is by written invitation and election according to qualifications in the club's charter or bylaws and the use of which is generally restricted to members and their guests.

Columbarium means a vault or other structure with recesses in the walls to receive the ashes of the dead, and shall be considered a permitted *accessory use* for cemeteries, mausoleums or a *place of worship*.

Commercial use means, in the MU-Ed zoning district, uses that include, but are not limited to, the sale, exchange, or transfer, of a product or service; accessory entertainment; recreational or amusement businesses; hotels, motels or clubs; commercial parking lots; production or manufacturing and a gross floor area greater than two hundred and fifty (250) square feet. To be considered a *commercial use* in the MU-Ed zoning district, the building or use must attract the general public. *Public University* sports venues and *Public University* operated auditoriums are examples of uses that are not considered a *commercial use*.

Common wall means the abutting walls of two buildings.

Community garden means land gardened collectively by a group of people. Gardening may include, but is not limited to, all types of horticulture such as flower, vegetable or field crops, and orchards containing berry, bush or tree crops.

Conceptual landscape plan means the same as a “landscape plan” as defined, except that shrubs, ground cover and vines may be indicated by size, quantity, name and general locations on the site.

Condominium means a building space designated for individual ownership, not including land, together with an interest in any common ownership land or improvements. Real estate is not a condominium unless the undivided interests in the common units are vested in the unit owners. See also “horizontal regime.”

Contiguous means in contact with.

Courtyard means a space, other than a setback yard, that is open and unobstructed to the sky, and located on the same lot with a building or group of buildings, which bound it on two or more sides and face each other. A court or courtyard typically provides amenities such as gardens, planters, seating, art or similar features. The width of a court shall be its least horizontal dimension as measured from the face of buildings or to columns, posts, overhangs or balconies, as applicable.

Figure 7-104 A.

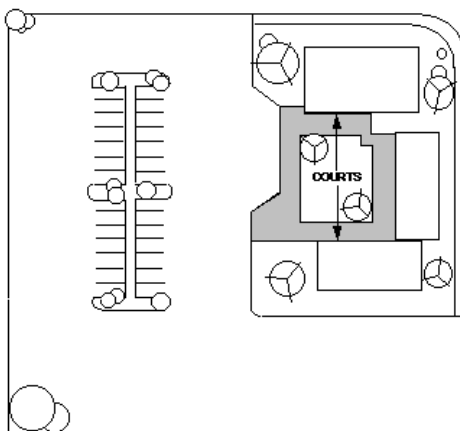

CPTED or Crime Prevention Through Environmental Design means the design and use of the built environment to lead to reduced fear and incidence of crime, and an improvement in the quality of life. In Tempe, CPTED is based upon five internationally recognized principles that are basic to crime prevention philosophy, which are Natural Surveillance, Access Control, Activity Support, Territoriality, and Maintenance. See Appendix for further explanation.

Customer point of service means any business which includes an entrance, lobby and service area for customers, such as a customer service window, booth or counter.

Customer service office means any office that has *customer point of service*.

Section 7-105 “D” Definitions.

Deferred Presentment Company means a business that engages in a transaction pursuant to a written agreement in which the licensee accepts a check and agrees to hold the check for at least five calendar days before presentment for payment or deposit. These services are commonly known as Pay Day Loans. See also, *financial institution, non-chartered*.

Develop means to construct or alter a structure or to make a physical change to the land including excavations and fills.

Development means all improvements on a site, including buildings, other structures, signs, parking and loading areas, landscaping, paved or graveled areas, and areas devoted to exterior display, storage or activities. Development includes improved open areas such as plazas and walkways, but does not include natural geologic forms or unimproved land. See also, "*alteration, exterior*".

Development, new means development of a site that was previously unimproved or that has had previously existing buildings demolished.

Development plan means a plan prepared to scale, showing all the buildings, site improvements (for example, parking, landscapes, walls, signs, lighting, access and circulation and utilities) and uses proposed for a specific property, consistent with Section 6-306. A development plan provides a precise plan of development which is supported by technical construction documents as necessary to carry out the implementation and enforcement of the development plan.

Density means the number of dwelling units per acre.

Density, allowable means the number of *dwelling* units allowed within the zoning district multiplied by the number of acres, rounded to the nearest one hundredth (100th) decimal place, per *gross site area*.

Disabilities, person with means a person who:

1. Has a physical or mental impairment which substantially limits one (1) or more of such person's major life activities;
2. Has a record of having such an impairment; or
3. Is regarded as having such an impairment. However, "person with disabilities" shall not include current, illegal use of or addiction to a controlled substance (as defined in Section 102 of the Controlled Substance Act [21 U.S.C. 802]), nor shall it include any person whose residency in a group home would constitute a direct threat to the health or safety of other individuals or would result in substantial physical damage to the property of others.

Domestic partner means a person who:

1. Shares your permanent residence;
2. Has resided with you for no less than twelve (12) consecutive months as proven by a lease or common ownership of real property;
3. Is no less than eighteen (18) years of age;
4. Is not a blood relative to who marriage would be prohibited in Arizona;
5. Is not currently married to another person;
6. Does not have any other domestic partner, spouse or spousal equivalent of the same or opposite sex;

7. Has not signed a domestic partner affidavit or declaration designating any other person as their domestic partner within 6 months; and
8. Is financially interdependent with you and has proven such by either common ownership or tenancy of real property and two (2) of the following:
 - a. Common ownership of a motor vehicle;
 - b. Joint bank or credit account; or
 - c. Designation as a beneficiary for life insurance or retirement benefits or under your partner's will or assignment of a durable power of attorney.

Donation bin means a large container for people to drop off used clothing and household goods for charitable purposes.

Drive-through use means a use involving a business that allows for transactions for goods or services without leaving a motor vehicle.

Drive-through facility means any window, automatic teller machine, kiosk, cashier or other feature of a business, building or site that is associated with a drive-through use.

Duplex means a building with two (2) attached dwelling units on one (1) lot or parcel.

Dwelling means an enclosed space providing complete, independent living facilities for a family including permanent provisions for living, sleeping, eating, cooking and sanitation.

Section 7-106 “E” Definitions.

Employment agency means a person or business association who recruits or offers to recruit employees for employers. Employment agencies are often called temporary agencies or contract work placement companies, specializing in finding temporary workers for a variety of tasks.

Entertainment means a presentation of, or participation in, live singing, dancing, musical instrumentation, dramatic, prosaic or poetic activities or similar activities.

1. Theater or similar use means a building used for movies, symphonic, plays or similar theatrical productions.
2. Amusement means an indoor entertainment or recreational use such as indoor miniature golf, ice rink, rock climbing, bowling or similar recreational or amusement activity.
3. Outdoor, permanent means an outdoor entertainment use such as an amphitheater, outdoor miniature golf, amusement park, or other similar outdoor activity.

Escort means a person who agrees or offers, for consideration, to privately model lingerie or to privately perform a striptease for another person; or who offers for pecuniary compensation, dates, socializes, visits, consorts with or accompanies others to or about social affairs, entertainment or private quarters.

Escort agency or bureau means a person or business association who furnishes, offers to furnish, or advertises to furnish escorts as one of its primary business purposes, for a fee, tip or other consideration.

City code reference—See TCC §16A-56, escort definitions and rules.

Section 7-107 “F” Definitions.

Family means:

1. One (1) or more persons related by the 3rd degree of consanguinity, adoption, marriage or as domestic partners as defined in Section 7-105, and not more than two (2) additional persons living together in a dwelling unit; or
2. Not more than three (3) persons who are not related by the 3rd degree of consanguinity, adoption, marriage or as domestic partners, living together in a dwelling unit.

Financial Institution, non-chartered means a business other than a state or federally chartered bank, credit union, mortgage lender, or savings and loan association, that offers check cashing services and/or loans for payment of a percentage fee for cashing a check or negotiable instrument, “payday loan” businesses that make loans upon assignments of wages received, or businesses that function as deferred presentment companies, which are licensed by the State in accordance with Arizona Revised Statutes or as amended.

Finished floor means the lowest occupiable space or floor of a building. Finished floor is not used as a base point for determination of building height (see *grade*).

Fitness center means a place or building where passive or active exercises and related activities are performed for the purpose of physical fitness, improved circulation or flexibility, self-defense, and/or weight control. Fitness centers include, but are not limited to athletic clubs, health clubs, fitness/health studios, and personal training with gym equipment. Such centers may have related activities incidental to the main use like spas.

Floor Area, Gross means the sum of all floor areas devoted to an activity (including mezzanines, outdoor retail and dining areas) and the thickness of exterior walls.

Floor Area, Net means the sum of all floor areas (including mezzanines, outdoor retail and dining areas) devoted to an activity, excluding exterior walkways and the thickness of exterior walls.

Floor Area Ratio means the ratio of gross floor area above grade on a site to the total net site area.

Full Cutoff means zero intensity at or above the horizontal plane (90 degrees above nadir) and limited to a value not exceeding 10% of lamp lumens at 80 degrees above nadir. Often referred to as “fully shielded”.

Section 7-108 “G” Definitions.

Garage, commercial means a building designed or used for servicing, repairing, or storing motor vehicles for compensation.

Garage, private means a building, or portion thereof, in which motor vehicles used by the tenants on the premises are stored or kept. A private garage may also provide public parking.

Garage, public parking means a building, or portion thereof, in which the public may park motor vehicles with or without a fee.

Geometric shape means the smallest area of a square, rectangle, circle or triangle used to calculate signage area of a sign face.

Grade means the top of curb, or top of crown of a street where no curb exists, as established at the midpoint of the front of the lot used for establishing building heights.

Group home for adult care, persons with disabilities and child shelter means a dwelling shared as a primary residence by adult persons or used as a child shelter, and including resident staff who live together as a single housekeeping unit in an environment in which staff persons provide care, education and activities for the residents; but not including medical institutional uses, alcoholism or drug treatment centers, community corrections facilities and adult shelter care facilities. This definition shall not apply to a home for the developmentally disabled as regulated by A.R.S. §36-582 to the extent of state preemption of local zoning regulations. For the purpose of this definition, children are under the age of eighteen (18).

Ground floor windows means windows located on the first floor.

Ground level means the portion of a building located on the first floor at grade.

Guest quarters means an attached or detached building used to house guests of the occupants of the main building, which is not rented or leased independently from the main building. Guest quarters are defined as having space for a room or sleeping room and a bathroom with shower/tub, toilet and sink, which does not provide ingress or egress internally through the main residence.

Section 7-109 “H” Definitions.

Hardscape means brick, concrete, wood, tile, paver, or other decorative hard surfaces used outside in lieu of or in conjunction with landscape materials such as trees, shrubs, turf, ground cover wood chips, or gravel.

Home occupation means a business activity that is carried out on the same site as a dwelling unit, and which is accessory to the household living use on the site.

Hospital means a building where the sick or injured are given in-patient medical or surgical care, including ancillary uses common to medical needs, such as pharmacies and medical labs. (Not a clinic.)

Horizontal regime means the three dimensional area in a condominium plat that is under a single ownership.

Hotel means a building that contains more than five (5) boarding rooms.

Hookah lounge means any business which primarily serves tobacco and related products, whereby patrons share the tobacco from a communal hookah or water pipe which is placed at each table. The business may sell beverages and snacks, but the gross sales of these items shall not exceed that of tobacco and related products.

Section 7-110 “I” Definitions.

Intensity means dwelling unit density, employment density and/or floor area ratio, whichever is applicable.

Intersection means the intersection of two (2) or more streets, alleys, or combination thereof.

Irrigation plan means a plan prepared to scale showing the layout and details of an irrigation system, including the type and location of all materials used.

Irrigation system means the combination of elements such as automatic controllers, meters, pressure vacuum breakers, pipes, valves, emitters, bubblers, spray heads, tubing and other materials designed for the purpose of transporting water to landscape improvements.

Section 7-111 “J” Definitions.

Junkyard means the use of a lot, or portion thereof, for the outdoor storage, keeping or abandonment of junk, dismantled automobiles or other vehicles, recyclable goods, or machinery, or parts thereof including scrap metals, rags or other scrap materials.

Section 7-112 “K” Definitions.

Kennel means any establishment at which dogs and cats are bred or raised for sale or adoption, boarded or cared for commercially, exclusive of dental, medical or surgical care, or pet grooming facilities which do not keep animals overnight.

City code reference—See TCC §6-21, definition of kennel.

Kindergarten see "nursery school".

Kitchen means an enclosed place equipped with cooking facilities.

Section 7-113 “L” Definitions.

Laboratory means a building, or portion thereof, used or intended to be used for experimentation, observation, testing or analysis.

Landfill means the use of a site for the permanent disposal or storage of rubble, construction debris, waste, miscellaneous by-products and any other materials not naturally found on the site.

Landscape, landscapes mean any combination of living plant material such as trees, shrubs, cacti, vegetative ground cover or turf; and structural features such as walkways, fences, walls, pergolas, arbors, gates, benches, plazas, works of art, water features (e.g., reflective pools, fountains, or the like), and similar features. Landscapes also include irrigation systems and any mulches, rock, topsoil, revegetation or the preservation, protection and replacement of existing landscape material.

Landscape, low water use means non-plant materials, plant materials native to the Sonoran, Chihuahuan and Mojave deserts, and plant materials with water consumption similar to the native plants.

Landscape, water intensive means bodies of water, water features, turf and non-native plants that require substantial water to survive.

Landscape plan means a plan prepared to scale showing elements such as trees, shrubs, ground cover, vines, sculpture, all walls, lighting, other organic and inorganic materials and an automatic irrigation system. The plan shall include a plant list, indicating the size and name, both botanical and "common", of all plant material to be used.

Laundry facility, self-service means a laundromat or similar business where customers wash their clothes.

Laundry facility, full-service means a business where clothes cleaning, tailoring and similar services are performed by employees, and may include delivery service.

Laundry facility, industrial means a full-service laundry facility that is greater than five thousand (5,000) square feet in floor area.

Lighting, photometrics plan means a plan prepared to scale showing the layout and details of lighting and photometrics, including the type and location of all materials used; the plan is overlaid on a screened landscape plan to avoid conflicts between lights and other features.

Livestock means cattle, horses, emus, llamas, ostriches, sheep, goats, or similar animals, except for swine.

Live-Work means a residential occupancy, by a single housekeeping unit, of one (1) or more rooms or floors in a building, which includes:

1. Cooking space and sanitary facilities in conformance with building code standards;
2. Adequate working space accessible from the living area, reserved for, and regularly used by, one or more persons residing therein; and
3. Working space uses that conform to the standards in Section 3-414.

Lodge see "*club, private*".

Lot means a parcel of land, or two (2) contiguous parcels, to be used as a unit under provisions of this Code, as shown in the records of the Maricopa County Recorder's office, and having its principal frontage on a city approved access way. In any district where a half-street has been dedicated not less than twenty-five (25) feet in width, lots facing on such half street shall be deemed to have frontage on a street. Where two (2) lots are to be built upon as one site, a lot-tie affidavit shall be recorded through the Community Development Department. More than two (2) lots shall require a subdivision.

Lot, corner means a lot abutting on two (2) or more intersecting streets where the interior angle of intersection does not exceed one hundred thirty-five degrees (135°). A corner lot shall be considered to be in that block in which the lot fronts.

Lot coverage (except as noted in Table 4-202C) means the area of a lot covered by a building or buildings expressed as a percentage of the net lot area, and measured from the exterior faces of foundation wall, slab and/or footings, and not including the sum of the several floors of a multistory building or canopies, arcades, porticos, awnings or similar unenclosed structures.

Lot, interior means a lot having one (1) side abutting on a street.

Lot, key means an interior lot, one (1) side of which is contiguous, or separated only by an alley, to the rear line of a corner lot.

Lot, through means a lot abutting two (2) parallel or approximately parallel streets.

Figure 7-113 A.

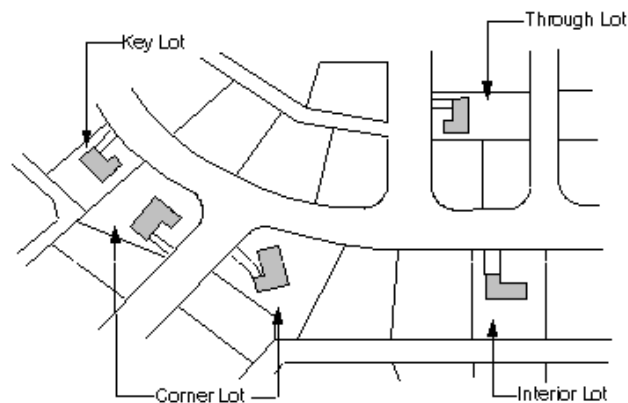

Lot dimensions means the following:

1. *Lot length.* The length of a lot shall be:
 - a. If the front and rear lot lines are parallel, the perpendicular distance between front and rear lot lines;
 - b. If the front and rear lot lines are not parallel, the distance between the midpoint of the front lot line and the midpoint of the rear lot line; and
 - c. If the side lot lines are not parallel, the shortest distance between the front lot line and a line parallel to the front lot line, not less than ten (10) feet long lying wholly within the lot.

Figure 7-113 B.

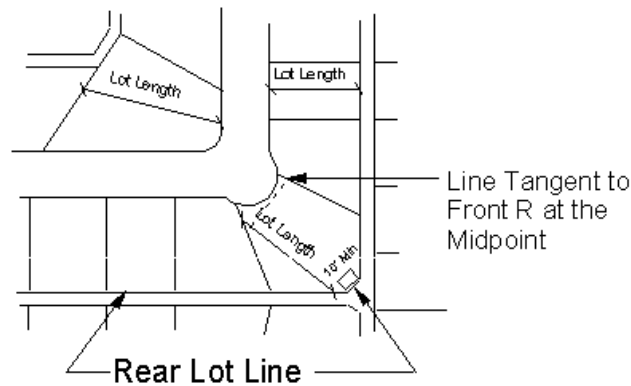

2. *Lot width.* The width of a lot shall be:
 - a. If the side lot lines are parallel, the shortest distance between these side lines; and
 - b. If the side lot lines are not parallel, the width of the lot shall be the length of a line measured perpendicular to the axis of the lot at a point which is equal to the required front yard setback for the district in which located. Such lot shall have a minimum length of seventy-five (75) feet beyond the point of required lot width. The axis of a lot shall be a line joining the midpoints of the front and rear lot lines.

Figure 7-113 C.

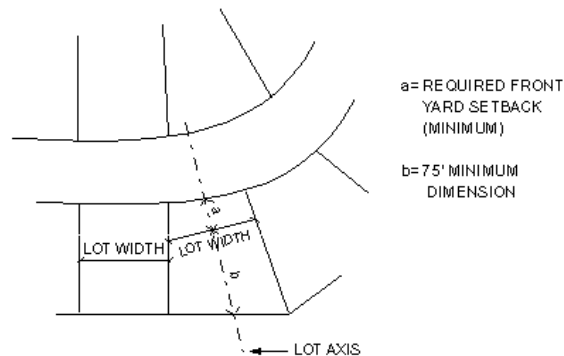

Lot line (property line) means the following:

1. *Front.* The front lot line of a lot shall be determined as follows:
 - a. *Corner lot.* The front lot line of a corner lot shall be the shorter of the two (2) lines adjacent to the streets. Where lines are equal, the front line shall be that line which is obviously the front by reason of the prevailing frontage of the other lots on the block. If such front is not evident, then either may be considered the front of the lot but not both;

- b. *Interior lot.* The front lot line of an interior lot shall be the line coterminous with the street frontage; and
- c. *Through lot (reverse frontage).* The front lot line of a through lot shall be that line which is the front by reason of the prevailing frontage of the other buildings on the block. Where such front lot line is neither evident nor established by a recorded plat, the Zoning Administrator shall determine the front lot line. Such a lot over two hundred (200) feet deep may be considered, for the purposes of this definition, as two (2) lots each with its own frontage, but this definition does not constitute a lot split.

Figure 7-113 D.

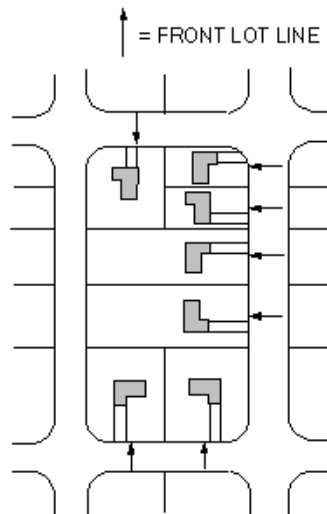

- d. *Two or more lots.* Where two (2) or more lots are used as a building site and where the main building crosses lot lines, then the entire area is considered as one (1) lot, except that the front of the parcel is determined to be the front of the individual lots as originally platted or laid out. Exception: the lots are considered as separate lots when the applicable building code standards are met (i.e., as in the case of uses with common walls).

Figure 7-113 E.

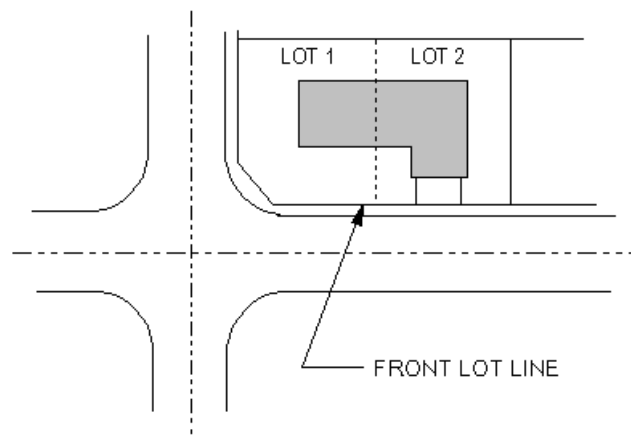

2. *Rear.* The rear lot line of a lot is that lot line opposite to the front lot line. Where the side lot lines meet in a point (if a radius, an extension of side lot lines to an intersecting point), the rear lot line shall be assumed to be a line not less than ten (10) feet long, lying within the lot and parallel to a line tangent to the front property line at its midpoint.
3. *Side.* The side lot lines are those lot lines connecting the front and rear lot lines.

Figure 7-113 F.

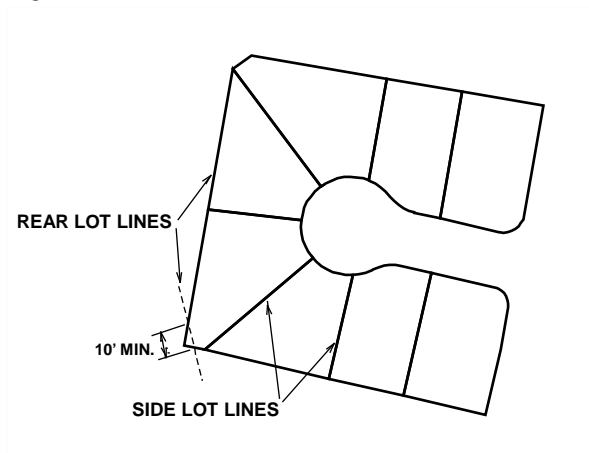

Section 7-114 “M” Definitions.

Maintenance means the replacing of a part, or parts, or the general periodic upkeep, of buildings, structures, landscaping and lighting, made unusable or deteriorated by ordinary wear or tear, vandalism, or by the weather that does change form, materials or color.

Manufactured building means a transportable building that is manufactured specifically to be transported and placed on a building site. Includes manufactured homes, mobile homes, manufactured office and storage buildings, and similar buildings.

Manufactured home means a transportable single-family dwelling conforming to the Manufactured Housing Construction and Safety Standards Code of the United States Department of Housing and Urban Development.

Massage establishment means a business that practices or administers within the city, any massage or body work techniques as defined in the Tempe City Code, Chapter 16A, for a fee or income of any kind.

Mechanical equipment means any equipment ancillary to the function of a structure including, but not limited to, heating or cooling equipment; pool pumps and filters; electrical equipment, transformers, satellite receiving earth stations, including dishes and antennas; vaults and cabinets for telecommunication towers; solar heating/cooling devices; exhaust stacks and roof vents; and similar equipment.

Medical marijuana means all parts of any plant of the genus cannabis whether growing or not, and the seeds of such plant to treat or alleviate a registered qualifying patient's debilitating medical condition or symptoms associated with the patient's debilitating medical condition.

Medical marijuana cultivation facility means an entity that cultivates or manufactures marijuana by the means of cooking, blending, or incorporating into consumable/edible goods or other means for a *medical marijuana dispensary*.

Medical marijuana dispensary means a not-for-profit entity that acquires, possesses, delivers, transfers, transports, supplies, sells or dispenses marijuana or related supplies to cardholders.

Mezzanine means an intermediate building story that projects in the form of a balcony.

Mini-warehouse means a commercial use in which enclosed storage space divided into separate compartments no larger than five hundred (500) square feet in area is provided for use by individuals to store personal items or by businesses to store material for operation of a business establishment at another location.

Mixed-Use means the combination on a site of residential uses with commercial uses.

Mixed use means, in the MU-Ed zoning district, uses that are a combination of either a *Public University* use or *Public University* related use and a commercial and/or residential use within the same building or project.

Mobile home means a dwelling unit built on a chassis in excess of eight (8) feet in width and forty (40) feet in length and containing complete electrical, plumbing and sanitary facilities, and designed to be installed on a temporary or a permanent foundation for permanent living quarters.

Mobile home park means a development providing rental or individually-owned spaces for occupancy by mobile homes, together with certain accessory buildings and uses provided for the benefit and enjoyment of the residents of the park.

Mobile home subdivision means a single-family subdivision that is to be used specifically as single-family residential uses, for mobile homes. Expressly prohibited for residential purposes are buses, recreational vehicles, motor homes, campers, trailers and other similar vehicles.

Model homes means single-family residential homes built and used by developers for the initial purpose of showing prospective buyers similar type homes for sale. Model homes are not used for residential purposes until the home is sold for this use.

Motel see "hotel".

Motor vehicle see "vehicle, motor".

Motorist amenity means any use that provides services to people in their vehicles or services the vehicle itself. Examples include *drive-throughs*, drive-ins, auto service station, or car wash.

Multi-family dwelling means two (2) or more dwelling units in one structure.

Section 7-115 "N" Definitions.

Non-conforming development means a development that does not fully comply with a Code standard because of setbacks, building height, lot coverage, signs, landscape or with some other standard of this Code.

Non-conforming use means a use that is not permitted outright and has not received conditional approval (e.g., use permit) in the district, but was lawfully established prior to it becoming nonconforming.

Nude model studio means a place where the primary use involves a person who regularly appears in a "state of nudity", displays "specified sexual activities" or the exposure of "specified anatomical areas" and is provided to be observed, sketched, drawn, painted, sculptured, photographed, or similarly depicted by other persons who transfer any form of consideration.

Nudity/state of nudity means without opaque non-flesh colored fabric fully covering the human anus, pubic region, male genitals, female genitals, and female breasts below the top of the areola.

Nursery and day care, in home means the use of a residence for the purpose of day care of children.

Nursery and day care school means any use, regulated by the State of Arizona, for day care of children and accommodating more than four (4) children. Some instructions may be offered in connection with such care. The use shall not be considered a "school" within the meaning of this Code. See also, *childcare centers*.

Section 7-116 "O" Definitions.

Office means a place where a particular kind of business is transacted or a service is supplied, excluding retailing, according to the following:

1. A place in which functions, such as consulting, record keeping or clerical work are performed; or
2. A place in which a professional person (e.g., a physician or lawyer) conducts professional services.

On-site lighting means any illumination source or illumination device, except lighting used for signs that is located on a lot and is visible from outside the building(s) on the lot.

Open space, usable means an open space, which is of appropriate size, shape, location, and topographic siting so that it provides landscaping, pedestrian access, or opportunity for outdoor recreational activity. Parking areas and driveways are not usable open spaces, except as permitted for convertible use with parking and/or open space (e.g., plaza).

Outdoor dining means a space dedicated to the adjacent restaurant for use by their patrons.

Overlay district means a special zoning district that modifies standards in an underlying zoning district with which the overlay zoning district is combined or creates alternative standards.

Outdoor storage means the use of land for secured containment of personal property, which may or may not be accessed by the public. Examples include landscape and garden supplies, construction materials or vehicles or boats.

Section 7-117 “P” Definitions.

Parking means parking areas for licensed motor vehicles or bicycles.

Parking affidavit means a document provided by and filed with the Community Development Department that transfers the rights to the unqualified availability of a specific number of parking spaces from one property (which can no longer take credit for them) to another for as long as the spaces are required by ordinance.

Parking lot means a parcel of land upon which vehicle parking is provided.

Parking lot, pay lot means a parking lot where the general public may park a motor vehicle by paying a charge or fee for the usage. Includes public and private parking lots.

Parking, shared means parking which serves multiple users to meet their required parking.

Parking, structured means a covered structure or portion of a covered structure that provides parking areas for motor vehicles. Parking on top of a structure, where there is gross building area below the parking, but nothing above it, is structured parking. The structure can be the primary structure for a commercial parking facility or be accessory to multi-dwelling residential, commercial, employment, industrial, institutional, or other structures. A structure that is accessory to a single-dwelling residential structure (including houses, attached houses, duplexes, mobile homes, or houseboats) is a garage and is not included as structured parking.

Parking, surface means a parking area for motor vehicles where there is no gross building area below the parking area and no gross building area or roof above it. Area occupied by small, permanent buildings, such as booths used by parking attendants, is not parking area. Temporary vending carts are not gross building area.

Pathway means a designated path that is typically a separate route of travel used exclusively for pedestrians and non-motorized vehicles.

Paved surface, asphalt means a surface treatment that consists of asphalt and mineral aggregate mixed together, laid down in a mat and compacted.

Paved surface, concrete means a surface treatment that consists of mineral aggregate and cement binder mixed together with water, which hardens into a stone-like material.

Person means any owner of personal property improvements or real property or person in possession or control of any personal property improvements or real property and includes any individual, firm, association, organization, partnership, business trust, corporation or company.

Photometric plan means an engineered point by point illumination plan that shows expected security lighting levels in foot-candles of light every ten (10) feet on center. A photometric plan is required to provide lighting levels for the entire site.

Place of worship means an institution, such as a church, temple, mosque, synagogue or other structure, together with its accessory structures, used primarily for religious worship. See “church”.

Planned area development overlay district (PAD overlay) means an application that modifies the standards of the base zone district(s) or creates alternate standards.

Plasma donation center means a medical clinic which accepts blood product donations, particularly plasma, and provides monetary payment for donations.

Poultry means chickens, ducks, geese, turkeys, guinea fowl, or other domestic fowl.

Primary building entrance means the entry to a building intended for the majority of public access

Primary use (Principle use) parking means property being used for parking automobiles not related to the on site use including remote (non-contiguous to a specific use) parking for students, employees or the general public. Parking may be provided on lots adjacent or across the street from a related use.

Principal use parking means a parking lot or parking structure that is on a site not with any other principal land use.

Property line means the same as “lot line”.

Pub (Public House) means a restaurant with a malt beverage and wine license that identifies itself as a pub; may serve spirits or be limited to beer and wine. See also, “bar”.

Public art means objects such as sculpture, water feature(s) or other multidimensional design that is viewed by the general public. The object(s) are to be located in spaces visible or accessible to the public in general so as to be enjoyed by the community at large, and are not to be a business logo or address marquee. Public art can also be used to enhance site safety and security. See also, criteria for public art approval in Appendix D, Art in Private Development.

Public University means a public funded educational institution maintained by the Arizona Board of Regents.

Public University use means, in the MU-Ed zoning district, the use of a project or facility for education, academic research, *Public University* community service or student life. This type of use is not open to the general public and use, participation or access is limited to persons enrolled in classes, working for a *Public University* or participating in a *Public University* program, project, or event. Without limiting the generality of the preceding sentence, residential halls operated by or for a *Public University* shall be a *Public University* use.

Public University related use means, in the MU-Ed zoning district, a use that supports the *Public University* uses and is not intended to attract the general public.

Public uses means a public project or city facility, such as a community center, park, municipal facility and other similar civic facilities.

Section 7-118 “Q” Definitions.
[reserved]

Section 7-119 “R” Definitions.

Recreational vehicle (RV) means any motor vehicle that is designed or customarily used for sleeping or camping including, but not limited to, motor homes and mounted truck campers.

Recycling Centers means a place for the following devices, including but not limited to, mobile recycling units, *reverse vending machines*, and *donation bins*, for drop-off or deposit of recyclable materials such as glass, metal, paper products and other materials as determined by the Zoning Administrator. Small recycling centers are defined as having an area of five hundred (500) square feet or less. Large recycling centers are facilities over five hundred (500) square feet or include machinery for processing materials.

Resale items means a business selling previously used and factory re-conditioned products to the consumer, including but not limited to consignment, donation distribution, rent-to-own, pawn, and antique stores.

Residential use means, in the MU-Ed zoning district, use open to the general public for rent or ownership. Residential halls operated by or for a *Public University* shall not be considered a residential use.

Restaurant means an establishment which derives at least forty percent (40%) of its gross revenue from the sale of prepared food.

Restaurant, drive-in means a building or structure where prepared food and drink are sold for consumption on the premises by order from and service to vehicular passengers outside the structure.

Restaurant, drive through means a building or structure where prepared food and drink are sold for consumption within the interior of the building, within exterior dining areas, or off the premises by order from vehicular passengers outside the structure.

Retail means the business of selling personal property directly to the ultimate consumer for any purpose other than for resale.

Reverse vending machine means a mechanical device that accepts one or more types of empty beverage containers, including aluminum cans, glass and plastic bottles and cartons, and issues a cash refund or a redeemable credit slip with a value not less than the container's redemption value. See also *recycling centers*.

Revitalize means giving new life in an area with existing development, not on vacant land, for the purpose of restoring economic vitality to the center.

Roof means a continuous solid sheathing cover on a structure which provides protection from rain, wind, sun or other natural elements.

Section 7-120 “S” Definitions.

School means any building, portion of building, or group of buildings which is designed, constructed, or used for education or instruction in any branch of knowledge. See below for varying types of schools. See also "tutoring center."

1. "Charter school" means a school operating under sponsorship of a public school district governing board, the State Board of Education or the State Board for Charter Schools and has been created pursuant to ARS 15-181.
2. "Instructional school" means a public or private school providing domestic, recreational, and other types of instruction such as dance, gymnastics, cooking, music, martial arts (without fitness center equipment), and fine arts.
3. "Private school" means any building, portion of building, or group of buildings used for elementary, secondary or higher education that does not secure the major part of its funding from a governmental agency.
4. "Public school" means any building, portion of building, or group of buildings used for elementary, secondary or higher education that secures the major part of its funding from a governmental agency.
5. "Vocational school" means an institution which teaches trades, business courses, hairdressing and similar skills on a post-secondary level.

Screening device means any landscape improvement or structure intended to fully or partially conceal an activity or mechanical element from view, adjacent uses, properties or streets.

Second story, single-family means any floor level that is above the ground or main floor of the dwelling, except mezzanines per building code.

Service means useful labor that does not produce a tangible commodity.

Service station means a place of business having pumps or storage tanks from which liquid fuel or lubricants are dispensed at retail directly into the motor vehicle. Sales and installation of auto accessories, washing, polishing, inspections, and cleaning may be carried on incidental to the sale of such fuel and lubricants. When a convenience store or restaurant is co-located with a service station, the Community Development Director, or designee, may interpret the store or restaurant as another primary use and not incidental to the service station.

Setback means the least horizontal distance between a building, structure, or wall, and a property line.

Figure 7-120 A.

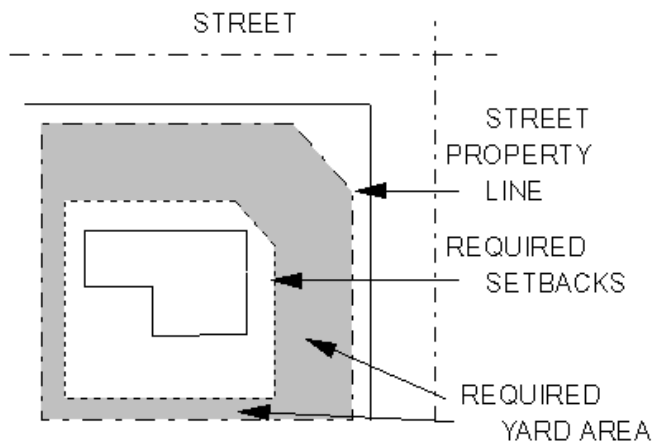

Sexual encounter center means a non-medical business, which offers for any form of consideration:

1. Activities between persons when one or more of the persons is in a "state of nudity"; or
2. The matching and/or exchanging of persons for "specified sexual activities".

Shade structure means a constructed form designed to protect an area from direct sunlight.

Sign means any device providing identification, advertising or directional information for a specific business, group of businesses, service, product, brand, person, organization, place or building. Including in this definition of signs are: graphic devices such as logos, trademarks, and attention attracting objects such as wind-driven spinners and portable sign devices, logo sculpture and, banners, balloons, streamers, strobe lights, flags, inflatable structures, projected picture signs, holographic projection signs, laser projected designs/images/copy and other attention attracting media and devices. Signs on buses, taxis, etc., are not exempt.

1. *Cemetery headstone, marker* means any tablet, grave markers, headstones, statuary or remembrances of persons or events that are noncommercial in nature;
2. *Complexes, centers* means any number of businesses greater than one that share the same site using common points of ingress and egress, or common parking facilities;
3. *Flags* means the state flag, United States flag, corporate flags for registered corporations, flags of foreign nations, flags displaying a business name, trademark, or logo, and decorative flags;
4. *Holiday decorations* means any decorative lighting, bunting, wreaths, laurels, trees, caricatures, and other objects that pertain to a specific traditionally accepted civic, patriotic or religious holiday. This definition does not include balloons;
5. *Roadside memorial* means the same as cemetery headstone/marker, except that such signs are located along street frontages and/or in city right-of-way;
6. *Sign, address* means a sign consisting of numerals and/or letters identifying a property address;
7. *Sign, advertising* means a sign that includes advertising copy or graphics relating to any service, product, person, business, place, activity or organization in addition to simple identification;
 - a. *Advertising copy* means copy includes, but is not limited to phone numbers, prices, announcements of sales, business hours, meeting times, individual or specific products or merchandise, and directional information. A business name, trademark, and street address, are not considered advertising copy;

8. *Sign, awning* means a sign, that is printed, painted, or affixed to an awning;
9. *Sign, banner* means a sign, that is painted or displayed upon cloth or other flexible material;
 - a. *Civic banner program* means a program administered by the community special event section under direction of the City Council that is intended to support the civic and cultural programs of the city through the implementation and use of banners displayed on city property. From time to time the City Council may choose to modify the program in order to meet these goals;
10. *Sign, billboard* means the same as off-premise sign;
11. *Sign, boutique directional* means a sign of a temporary nature used to direct traffic to an in-home boutique;
12. *Sign, brand identification* means a sign that advertises a specific product or service that is sold within a business;
13. *Sign, building mounted* means a sign that is directly attached to the face of a building;
14. *Sign, ceased non-conforming* means a sign which has not been utilized or has not identified a business on the site for a period of twelve (12) months or more, and does not conform to the standards of this code;
15. *Sign, marquee* is a sign, that utilizes changeable letters, intermittent or scrolling illumination for copy or numerals;
16. *Sign, construction* means a sign that identifies the parties included in a construction project that has been granted a building permit;
17. *Sign, directional* means a sign, that is limited to copy offering pertinent directional information for the purpose of assisting in the flow of vehicular or pedestrian traffic;
18. *Sign, directory* means a sign that lists the name, use or location within a building, complex, or multi-tenant development;
19. *Sign, flag-mounted* means a sign that projects from the wall of a building perpendicular to a wall surface;
20. *Sign, freestanding* means a sign that is erected or mounted on its own self-supporting permanent structure or base detached from any supporting elements of building;
21. *Sign, future development* means a sign, that announces the proposed development of property prior to the issuance of a building permit;
22. *Sign, going out of business* means a sign indicating that the business displaying the sign will cease and be discontinued at a specific location;

23. *Sign, grand opening* means a sign that is utilized to indicate that a new business is now open to the public;
24. *Sign, identification* means a sign that includes as copy only the name of business, place, organization, building or person it identifies;
25. *Sign, illuminated* means a sign whose surface is lit, internally or externally, and that identifies, advertises or attracts attention to a use or activity on the premise;
26. *Sign, intermittent or flashing* means a sign which by means of electrical devices gives the effect of intermittent movement, or changes to give two or more visual effects, or alternates with a lit and unlit effect;
27. *Sign, lead-in* means a temporary portable sign used to direct pedestrian or vehicular traffic to a home (or residential unit) that is for sale or rent;
28. *Sign, menu board* means a permanently mounted sign advertising the bill of fare for a restaurant, drive-in or drive-through restaurant;
29. *Sign, multi-tenant* means a sign that includes as copy, the names of two (2) or more businesses, places, organizations, buildings or persons it identifies;
30. *Sign, off-premise/off-site* means a sign that directs attention to a business, product, commodity, service, entertainment or attraction sold, offered or existing elsewhere than upon the same lot where such sign is displayed. The term off-premise/off-site sign shall include an outdoor advertising sign (billboard) on which space is leased, rented, or donated by the owner thereof to others for the purpose of conveying a commercial or non-commercial message;
31. *Sign, on-premise/on-site* means a sign that directs attention to a business, product, commodity, service, entertainment or attraction sold, offered or existing upon the same lot where such sign is displayed;
32. *Sign, permitted special event* means banners displayed as part of a permitted special event as administered by the special events committee.
33. *Sign, political* means a temporary sign used to advertise the candidacy of an individual, ballot proposition, or to encourage citizens to vote;
34. *Sign, portable (sandwich sign)* means any sign that is not permanently affixed to any structure on a site or permanently ground mounted;
35. *Sign, projecting* means a sign mounted to the façade of a building and extending from the building façade;
36. *Sign, pump-topper* means a sign affixed to the top or sides of an operable fuel-dispensing pump.
37. *Sign, roof-mounted* means a sign that projects above the highest point of the roof line, parapet or fascia of a building;

38. *Sign, sale, lease or rent* means a temporary sign used to advertise the availability of real property;
39. *Sign, service station* means a permanently mounted sign displaying business identification and the retail cost of a gallon of *motor vehicle* fuel, or cost of electrical recharging on the premises of a business that provides motor vehicle fuels or electrical power;
40. *Sign, significant event* means signs displayed for any type of event, including an anniversary, special sale, change in ownership or management, or similar event;
40. *Sign, soffit* means a sign that is suspended from the underside of a lintel, arch or other overhead spanning member and is hung perpendicular to a vertical wall surface;
41. *Sign, subdivision/apartment community advertising* means a temporary sign used to advertise the initial sale of lots/units in a recorded subdivision or the initial lease for units in an apartment community;
42. *Sign, subdivision identification* means a permanent sign used to identify the name of a particular recorded subdivision;
43. *Sign, unauthorized* means a sign that is illegally displayed in the City of Tempe;
44. *Sign, upright* means a way-finding sign displayed perpendicular to the ground that is not permanently affixed to any structure or the ground.
45. *Sign, wall mounted* means a sign that is permanently affixed to any vertical portion of a building for which the sign is intended to identify or advertise; and
46. *Sign, window* means a sign or signage placed in a window so as to attract the attention of persons outside of the building where the sign or signage is placed.

Sign package criteria means a detailed description, including, but not limited to, type, size, color, and location of all signage.

Single-family dwelling means a dwelling for one family on an individual lot.

Single-family dwelling, attached means two or more single-family dwellings with common walls; except does not include single-family dwellings and accessory dwellings sharing a common wall(s).

Site area, gross means the total ground area purchased by the present owner, including any proposed portions to be dedicated for public use such as, streets, alleys, easements or other. The allowable density is based on gross site area.

Site area, net means the remaining ground area of the gross site area after deleting all portions for proposed perimeter rights-of-way and alleys.

Figure 7-120 B.

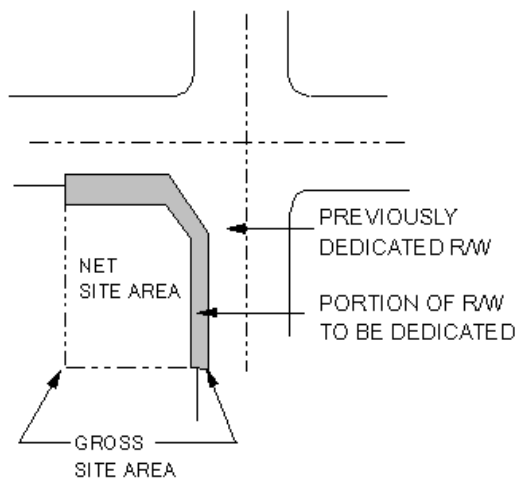

Site Plan means a plan prepared to scale, showing all buildings, site improvements (for example, parking, landscapes, walls, signs, lighting, access and circulation and utilities) and uses proposed for a specific property. A site plan provides a conceptual plan of development prepared to support zoning modification requests and/or requests for use permits. The plan is designed to demonstrate compliance with Zoning and Development Code provisions while expressing the property owner's intent of land use and functional compatibility with contextual conditions.

Small animal means *poultry* as defined herein, pot-bellied pigs, rabbits, or other similar small animals.

Smoking establishment means any business or location that is dedicated, in whole or in part, to the use of tobacco or other substances emitting smoke, including but not limited to establishments also referred as cigar bars or lounges, hookah bars or lounges, and tobacco clubs or bars.

Specified anatomical areas means the human anus, pubic region, male genitals, female genitals, or female breast below the top of the areola that are less than completely and opaquely covered by non-flesh colored fabric; or human genitals in a state of sexual arousal, even if completely and opaquely covered.

Specified sexual activities means actual or simulated sexual intercourse, masturbation, oral copulation, sodomy, flagellation, bestiality, fondling or other erotic touching of human genitals, pubic region, buttocks, anus, the female breast or any combination thereof. As well as, human genitals in a state of sexual arousal or excretory functions as part of or in connection with any of the activities set forth herein.

Station area means an area lying within a prescribed distance of a light rail transit station.

Street means a right-of-way and the improvements contained therein, consistent with the Comprehensive Transportation Plan.

Street frontage means the portion of a building or property facing a public street.

Street, private means a local street that is privately owned and maintained.

Street, public means a street built to city standards and dedicated for public use. For specific street types, refer to the Comprehensive Transportation Plan.

Street property line means the boundary which separates the required or actual street right-of-way, whichever is greater, whether dedicated or not, from abutting property according to the City of Tempe Street Standards.

Figure 7-120 C.

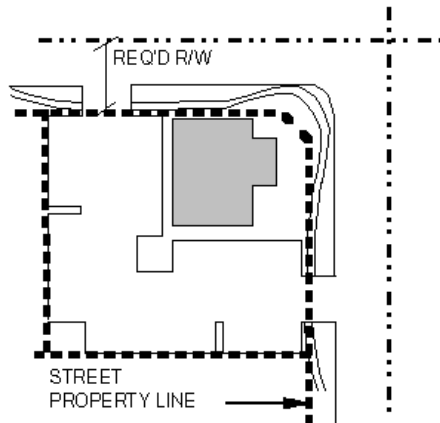

Structure means any object constructed in or on the ground. Structure includes buildings, decks, fences, towers, flag poles, signs, and other similar objects. Structure does not include paved areas or vegetative landscaping materials.

Subdivision means the land divided into two (2) or more lots, tracts or parcels of land, or, if a new street is involved, any such property which is divided into two (2) or more lots, tracts or parcels of land, or any such property, the boundaries of which have been fixed by a recorded plat, which is divided into more than two (2) parts. *Subdivision* also includes any condominium, community apartment, townhouse or similar project containing two (2) or more parcels, in which an undivided interest in the land is coupled with the right of exclusive occupancy of any unit located thereon.

City code reference—See TCC §30, Subdivisions.

Section 7-121 “T” Definitions.

Tattoo, body piercing establishment means any establishment offering indelible designs, letters, scrolls, figures, symbols or other marks that are placed on or under the skin with ink or colors by the aid of needles or other instruments and that cannot be removed without a surgical procedure; any establishment offering designs, letters, scrolls, figures or symbols or other marks done by scarring/branding on or under the skin; any establishment where decorations or other devices are inserted into the skin; any establishment using techniques such as penetrating, perforating, boring or creating a hole in the skin or another human body part; or any establishment whose primary function is permanent body alteration for non-surgical purposes. The following establishments shall be exempt from this definition: those where offering permanent facial make-up/cosmetics ancillary to the primary business; those where procedures are performed by a person authorized by the laws of this state to practice medicine, osteopathy, chiropractic, podiatry, naturopathy or acupuncture and the procedures are performed in conformity with the standards of that profession; those where procedures are performed by registered nurses, licensed practical nurses or technicians, when acting under the supervision of a licensed physician or osteopath; those where the only type of piercing offered is ear piercing.

Telecommunications Hotel means a windowless controlled environment buildings which allow for businesses to lease computer server space for connection to local exchange carriers, interexchange carriers, Internet service providers, competitive access providers and telephone services. In addition to voice and data connectivity, the amenities include controlled temperature and humidity, 24-hour security, fire detection/suppression systems and generator power backup. These facilities have no pedestrian activity associated with the use.

Tobacco retailer means any person or business who primarily sells or offers for sale, tobacco, tobacco products, or tobacco paraphernalia, or who distributes samples of tobacco products or paraphernalia. These businesses include but are not limited to, tobacco shops, cigars and pipe retailer, cigarette or electronic cigarette retailer, and *smoking establishments*.

TOD means a Transportation Overlay District, which creates an overlay to existing zoning to encourage development supportive of light rail, bus, bicycle and pedestrian uses.

(TOD) Corridor means the portion of the Overlay District not located within a *Station Area*.

(TOD) Station Area means the portion of the Overlay District located Only areas within 400 linear feet of a light rail transit station are referred to as *Station Areas*, measured from the center point of the platform, extending 400 feet in a linear direction along the center of any public right of way, including only properties adjacent to the public right-of-way, with required uses, development and design standards that encourage intensified development around the light rail stations.

Tourist court see "hotel".

Townhouse means an estate in real property consisting of an undivided interest in common in a portion of a parcel of real property together with a separate interest in a subdivided lot.

Trailer means any platform or frame with wheels that is designed or customarily used to carry personal property and for being drawn or towed by a motor vehicle including, but not limited to, travel trailers and camping trailers.

Trailer park means any lot, tract, or parcel of land used or offered for use in whole or in part for the rental of trailer sites for the parking of three (3) or more recreational vehicles.

Transit shelter means a structure provided at a bus or train stop to provide shelter from weather and/or sun to transit patrons waiting at the stop.

Tutoring center means a facility that provides assistance and instruction to students enrolled in schools. The facilities themselves are not schools where attendance results in the confirmation of a degree.

Section 7-122 “U” Definitions.

Use permit means a permit granted to a property owner or lessee to conduct a use not otherwise permitted; or the use of alternate development standards following a compatibility review.

Section 7-123 “V” Definitions.

Variance means permission granted by the city to deviate from a regulation of the city’s development standards.

Vehicles, motor means vehicles that have their own motive power and that are used for the transportation of people or goods on streets. Motor vehicle includes, but not limited to motorcycles, passenger vehicles, trucks and recreational vehicles with motive power.

Vehicle repair means an automotive retail sales and service use in which general motor repair work is done as well as the replacement of new or reconditioned parts in motorized vehicles of ten thousand (10,000) pounds or less gross vehicle weight; but not including any operation included in the definition of "*auto body repair*."

Video arcade see "*amusement game arcade*".

Section 7-124 “W” Definitions.

Warehouse means the storage of goods of any type without retailing operations on a parcel or within a structure.

1. *Commercial.* Any warehouse that is ancillary to a use on-site for storage of related materials.

Wholesaling means the selling of goods or merchandise to retailers or jobbers for resale to the ultimate consumer.

Wireless Telecommunication Facilities (WTF) means an un-staffed facility for the transmission and reception of radio or microwave signals for commercial communications. WTFs are composed of two or more of the following components: (1) antenna; (2) support structure; (3) equipment enclosures; and (4) security barrier.

Section 7-125 “X” Definitions.

[reserved]

Section 7-126 “Y” Definitions.

Yard means a required space on a lot other than a court, which is open and unobstructed to the sky, and which is measured from a property line inward to the required setback specified herein. Such required yards shall be measured across the full width or across the full depth of a lot as applicable.

Figure 7-126 A.

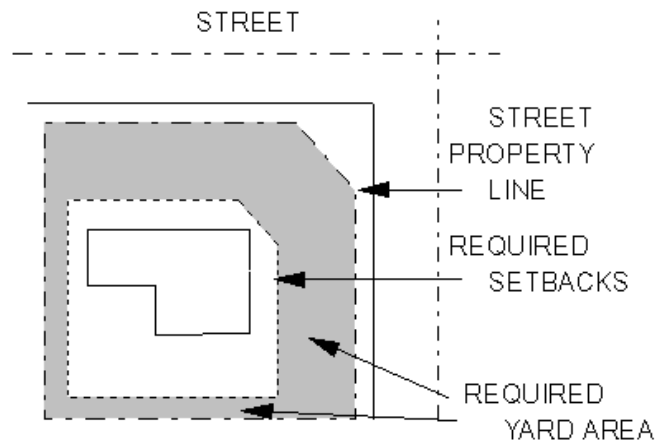
**Section 7-127 “Z” Definitions.**

Zero-lot line means a use with at least one side yard setback equal to zero (0).